

ST6045C SCHOTTKY RECTIFIER

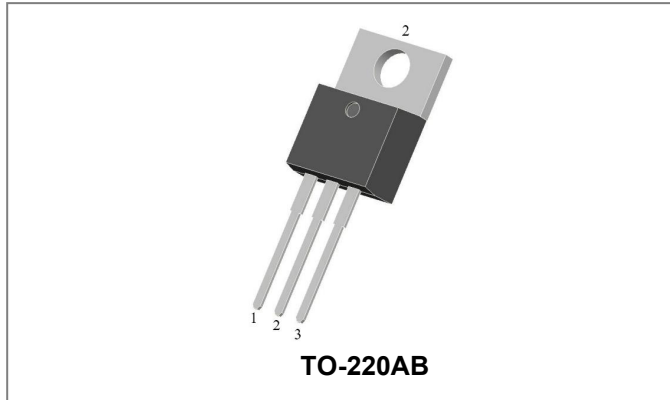

Features

- 150 °C T_J operation
- Ultralow forward voltage drop
- High purity, high temperature epoxy encapsulation for enhanced mechanical strength and moisture resistance
- High frequency operation
- Trench MOS Schottky technology
- Terminals finish: 100% Pure Tin
- This is a Pb – Free Device
- All SMC parts are traceable to the wafer lot
- Additional testing can be offered upon request

Circuit Diagram

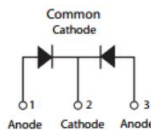

Applications

- Switching power supply
- Converters
- Free-Wheeling diodes
- Reverse battery protection

Maximum Ratings(limiting values, at 25 °C unless otherwise specified):

Characteristics	Symbol	Condition	Max.	Units
Peak Repetitive Reverse Voltage	V _{RRM}	-	45	V
Working Peak Reverse Voltage	V _{RWM}			
DC Blocking Voltage	V _R			
Average Rectified Forward Current (Per Device)	I _{F(AV)}	50% duty cycle @T _c =125°C, rectangular wave form	30(Per Leg) 60(Per Device)	A
Peak One Cycle Non-Repetitive Surge Current(Per Leg)	I _{FSM}	8.3ms, Half Sine pulse	320	A

Electrical Characteristics:

Characteristics	Symbol	Condition	Typ.	Max.	Units
Forward Voltage Drop (Per Leg) *	V _{F1}	@ 10A, Pulse, T _J = 25 °C	0.44	-	V
		@ 15A, Pulse, T _J = 25 °C	0.47	-	
		@ 30A, Pulse, T _J = 25 °C	0.58	0.64	
	V _{F2}	@ 10A, Pulse, T _J = 125 °C	0.35	-	V
		@ 15A, Pulse, T _J = 125 °C	0.38	-	
		@ 30A, Pulse, T _J = 125 °C	0.51	0.56	
Reverse Current (Per Leg) *	I _{R1}	@V _R = rated V _R , T _J = 25°C	0.09	3000	uA
	I _{R2}	@V _R = rated V _R , T _J = 125°C	27	50	mA

* Pulse width < 300 μs, duty cycle < 2%

Thermal-Mechanical Specifications:

Characteristics	Symbol	Condition	Specification	Units
Junction Temperature	T_J	-	-55 to +150	$^{\circ}\text{C}$
Storage Temperature	T_{stg}	-	-55 to +150	$^{\circ}\text{C}$
Typical Thermal Resistance Junction to Case(Per Leg)	$R_{\theta JC}$	DC operation	2.2	$^{\circ}\text{C}/\text{W}$

Ratings and Characteristics Curves

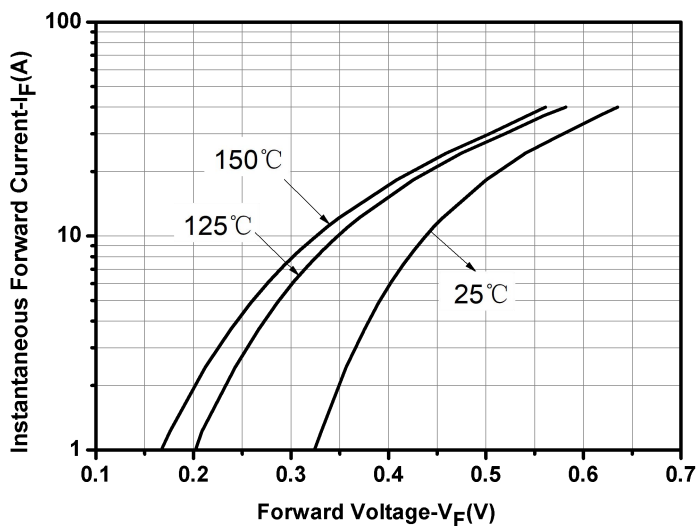

Fig.1-Typical Forward Voltage Characteristics

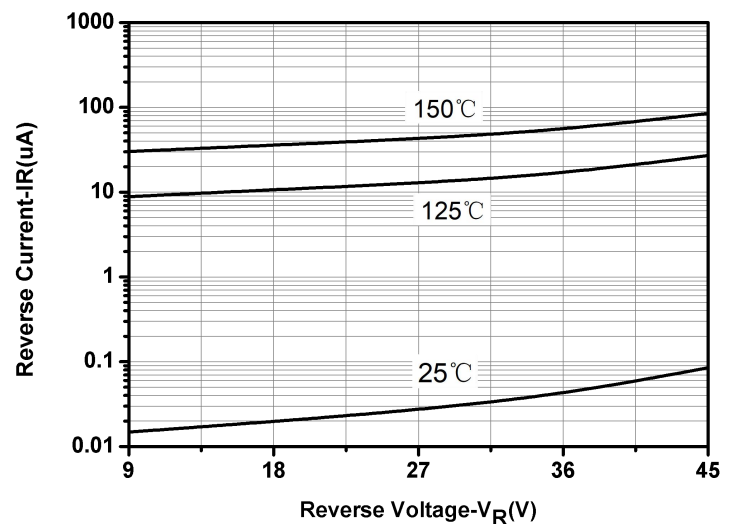

Fig.2-Typical Reverse Characteristics

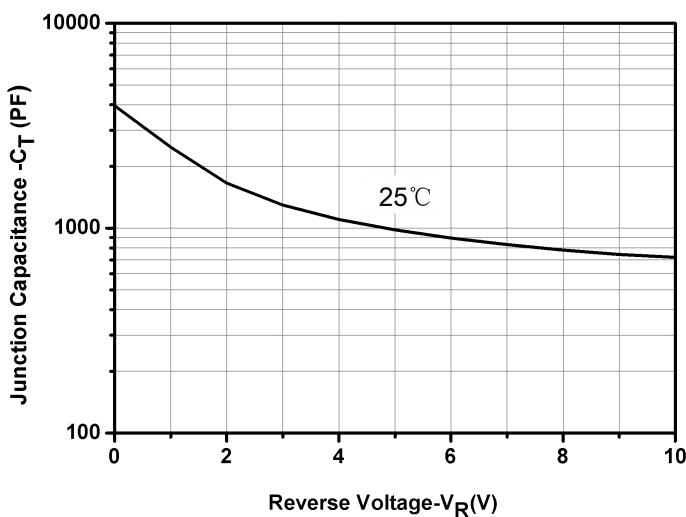
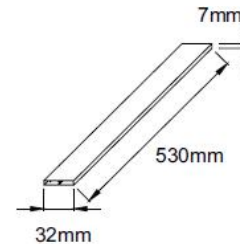
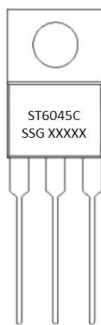

Fig.3-Capacitance vs. Reverse Voltage

Tube Specification

Device	Package	Weight	Shipping
ST6045C	TO-220AB	2.0	50pcs / tube

Tube Specification(TO-220AB)

Marking Diagram

Where XXXXX is YYWWL

ST = Device Type
 60 = Forward Current (60A)
 45 = Reverse Voltage (45V)
 C = Configuration
 SSG = SSG
 YY = Year
 WW = Week
 L = Lot Number

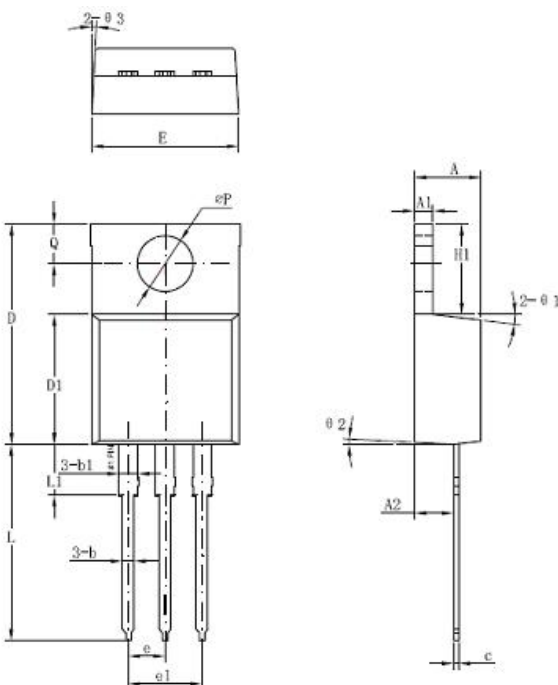
Cautions: Molding resin
 Epoxy resin UL:94V-0

Mechanical Dimensions TO-220AB

Symbol	Dimensions in millimeters		
	Min	Typical	Max
A	3.56	-	4.83
A1	0.51	-	1.4
A2	2.03	-	2.92
b	0.38	-	1.02
b1	1.14	-	1.78
c	0.31	-	0.61
D	14.22	-	16.51
D1	8.38	-	9.42
E	9.65	-	10.67
e	-	2.54	-
e1	-	5.08	-
H1	5.84	-	6.86
L	12.7	-	14.73
L1	-	-	6.35
ΦP	-	3.56	-
Q	2.54	-	3.43

Technical Data
Data Sheet N2583, Rev. -



DISCLAIMER:

1- The information given herein, including the specifications and dimensions, is subject to change without prior notice to improve product characteristics. Before ordering, purchasers are advised to contact the SMC Diode Solutions sales department for the latest version of the datasheet(s).

2- In cases where extremely high reliability is required (such as use in nuclear power control, aerospace and aviation, traffic equipment, medical equipment, and safety equipment), safety should be ensured by using semiconductor devices that feature assured safety or by means of users' fail-safe precautions or other arrangement.

3- In no event shall SMC Diode Solutions be liable for any damages that may result from an accident or any other cause during operation of the user's units according to the datasheet(s). SMC Diode Solution assumes no responsibility for any intellectual property claims or any other problems that may result from applications of information, products or circuits described in the datasheets.

4- In no event shall SMC Diode Solutions be liable for any failure in a semiconductor device or any secondary damage resulting from use at a value exceeding the absolute maximum rating.

5- No license is granted by the datasheet(s) under any patents or other rights of any third party or SMC Diode Solutions.

6- The datasheet(s) may not be reproduced or duplicated, in any form, in whole or part, without the expressed written permission of SMC Diode Solutions.

7- The products (technologies) described in the datasheet(s) are not to be provided to any party whose purpose in their application will hinder maintenance of international peace and safety nor are they to be applied to that purpose by their direct purchasers or any third party. When exporting these products (technologies), the necessary procedures are to be taken in accordance with related laws and regulations..