

SMF5.0CA-SMF170CA TRANSIENT VOLTAGE SUPPRESSOR

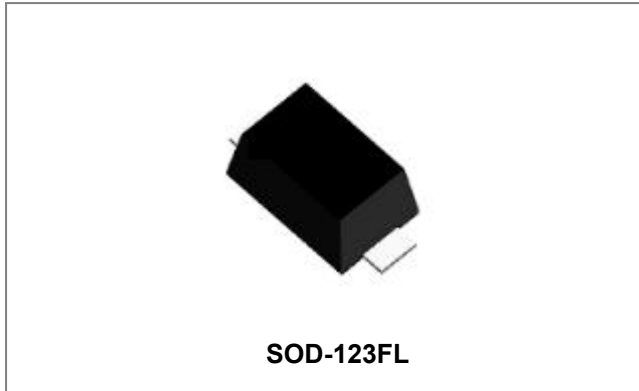

Features

- For surface mounted applications in order to optimize board space
- Low profile space
- Glass passivated chip
- Low inductance
- Excellent clamping capability
- Very fast response time
- This is a Halogen Free device
- “-A” is an AEC-Q101 qualified device (V_{RWM} more than 10 V)
- Terminals finish: 100% Pure Tin
- 200 W peak pulse power capability with a 10/1000 μ s waveform

Circuit Diagram



Mechanical Data

- Case: JEDEC SOD-123FL molded plastic over passivated chip
- Terminals: Solder plated, solderable per MIL-STD-750 Method 2026

Maximum Ratings@ $T_A=25^\circ\text{C}$ unless otherwise specified

Parameter	Symbol	Value	Unit
Peak pulse power dissipation with a 10/1000 μ s waveform (Note1,2)	P_{PPM}	200	W
Typical Thermal Resistance Junction to Lead	$R_{\theta JL}$	100	$^\circ\text{C/W}$
Typical Thermal Resistance Junction to Ambient	$R_{\theta JA}$	220	$^\circ\text{C/W}$
Operating Junction and Storage Temperature Range	T_J, T_{STG}	-55 to +150	$^\circ\text{C}$

- Notes:**
1. Non-repetitive current pulse and derated above $T_A=25^\circ\text{C}$
 2. Mounted on 5.0mm² copper pads to each terminal.

Electrical Characteristics @T_A=25°C unless otherwise specified

DEVICE PART NO.	MARKING CODE	STAND-OFF VOLTAGE V _{RWM} (V)	BREAKDOWN VOLTAGE V _{BR} (V) @IT ⁽²⁾		TEST CURRENT I _T (mA)	MAXIMUM CLAMPING VOLTAGE @IPP V _C (V)	MAXIMUM PEAK PULSE CURRENT ⁽³⁾ I _{PP} (A)	MAXIMUM REVERSE LEAKAGE @VRWM ⁽⁴⁾ IR(μA)
			Min.	Max.				
SMF5.0CA	FE	5.00	6.40	7.00	10	9.2	21.70	400
SMF6.0CA	FG	6.00	6.67	7.37	10	10.3	19.40	400
SMF6.5CA	FK	6.50	7.22	7.98	10	11.2	17.90	250
SMF7.0CA	FM	7.00	7.78	8.60	10	12.0	16.70	100
SMF7.5CA	FP	7.50	8.33	9.21	1	12.9	15.50	50
SMF8.0CA	FR	8.00	8.99	9.83	1	13.6	14.70	25
SMF8.5CA	FT	8.5	9.44	10.40	1	14.4	13.90	10
SMF9.0CA	FV	9.0	10.00	11.10	1	15.4	13.00	5
SMF10CA	FX	10	11.10	12.30	1	17.0	11.80	2.5
SMF11CA	FZ	11	12.20	13.50	1	18.2	11.00	2.5
SMF12CA	HE	12	13.30	14.70	1	19.9	10.10	2.5
SMF13CA	HG	13	14.40	15.90	1	21.5	9.30	1
SMF14CA	HK	14	15.60	17.20	1	23.2	8.60	1
SMF15CA	HM	15	16.70	18.50	1	24.4	8.20	1
SMF16CA	HP	16	17.80	19.70	1	26.0	7.70	1
SMF17CA	HR	17	18.90	20.90	1	27.6	7.20	1
SMF18CA	HT	18	20.00	22.10	1	29.2	6.80	1
SMF20CA	HV	20	22.20	24.50	1	32.4	6.20	1
SMF22CA	HX	22	24.40	26.90	1	35.5	5.60	1
SMF24CA	HZ	24	26.70	29.50	1	38.9	5.10	1
SMF26CA	JE	26	28.90	31.90	1	42.1	4.80	1
SMF28CA	JG	28	31.10	34.40	1	45.4	4.40	1
SMF30CA	JK	30	33.30	36.80	1	48.4	4.10	1
SMF33CA	JM	33	36.70	40.60	1	53.3	3.80	1
SMF36CA	JP	36	40.00	44.20	1	58.1	3.40	1
SMF40CA	JR	40	44.40	49.10	1	64.5	3.10	1
SMF43CA	JT	43	47.80	52.80	1	69.4	2.90	1
SMF45CA	JV	45	50.00	55.30	1	72.7	2.80	1
SMF48CA	JX	48	53.30	58.90	1	77.4	2.60	1
SMF51CA	JZ	51	56.70	62.70	1	82.4	2.40	1
SMF54CA	XE	54	60.00	66.30	1	87.1	2.30	1
SMF58CA	XG	58	64.40	71.20	1	93.6	2.20	1
SMF60CA	XK	60	66.70	73.70	1	96.8	2.10	1
SMF64CA	XM	64	71.10	78.60	1	103.0	2.00	1
SMF70CA	XP	70	77.80	86.00	1	113.0	1.80	1
SMF75CA	XR	75	83.30	92.10	1	121.0	1.70	1
SMF78CA	XT	78	86.70	95.80	1	126.0	1.60	1
SMF85CA	XV	85	94.40	104.00	1	137.0	1.50	1
SMF90CA	XX	90	100.00	111.00	1	146.0	1.40	1
SMF100CA	XZ	100	111.00	123.00	1	162.0	1.30	1

DEVICE PART NO.	MARKING CODE	STAND-OFF VOLTAGE	BREAKDOWN VOLTAGE V_{BR} (V) @ $I_T^{(2)}$		TEST CURRENT	MAXIMUM CLAMPING VOLTAGE @IPP	MAXIMUM PEAK PULSE CURRENT ⁽³⁾	MAXIMUM REVERSE LEAKAGE @VRWM ⁽⁴⁾
			Min.	Max.				
SMF110CA	TE	110	122.00	135.00	1	177.0	1.20	1
SMF120CA	TG	120	133.00	147.00	1	193.0	1.00	1
SMF130CA	TK	130	144.00	159.00	1	209.0	1.00	1
SMF150CA	TM	150	167.00	185.00	1	243.0	0.80	1
SMF160CA	TP	160	178.00	197.00	1	259.0	0.80	1
SMF170CA	TR	170	189.00	209.00	1	275.0	0.70	1

Notes: (1) "A" Suffix Designates 5% Tolerance Devices, No Suffix Designates 10% Tolerance Devices

(2) I_T pulse test: $t_p \leq 5.0\text{mS}$

(3) Surge current waveform 10 / 1000 μ S.

Ratings and Characteristics Curves

Fig.1 Peak Pulse Power Rating Curve

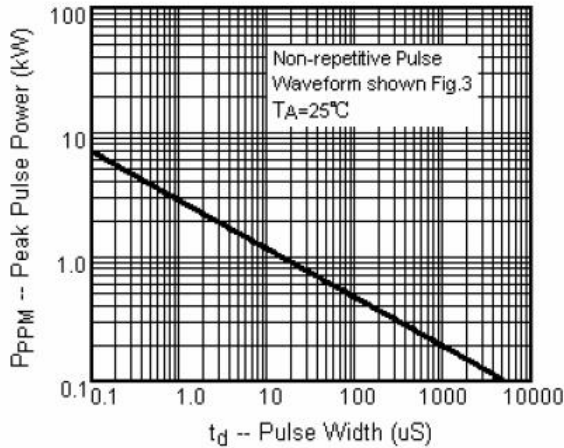

Fig.2 Pulse Derating Curve

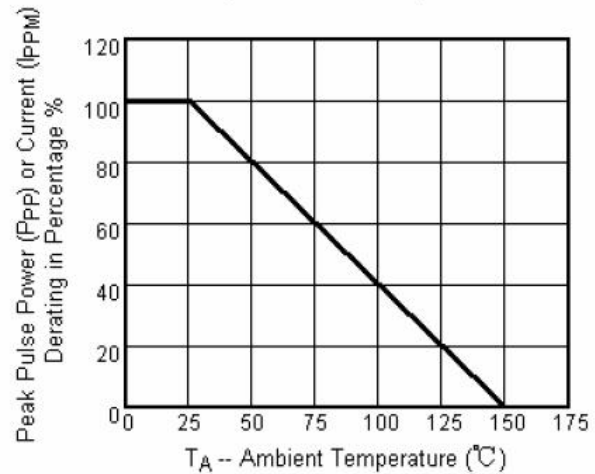

Fig.3 Pulse Waverform

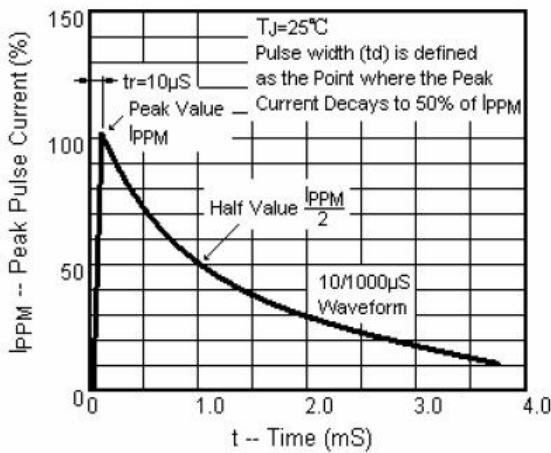

Fig.4 Typical Junction Capacitance

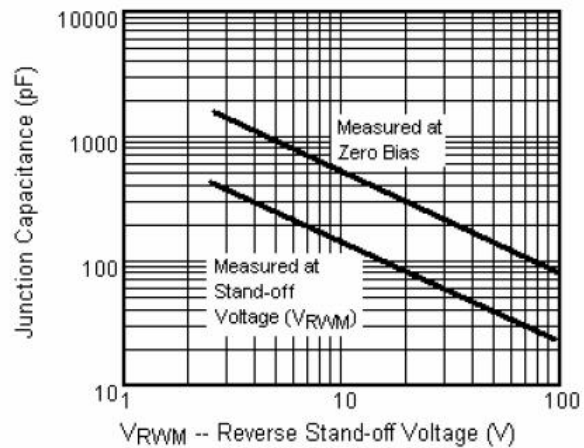
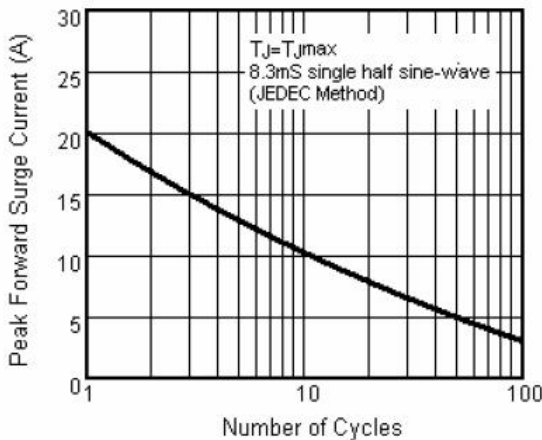
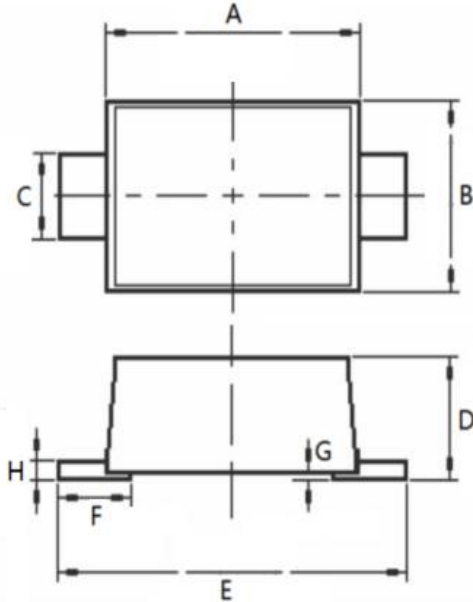

Fig.2 Maximum Non-Repetitive Peak Forward Surge Current



Mechanical Dimensions SOD-123FL(Millimeters/Inches)



SYMBOL	Millimeters		Inches	
	Min.	Max.	Min.	Max.
A	2.50	3.05	0.098	0.138
B	1.55	1.95	0.061	0.077
C	0.60	1.10	0.024	0.043
D	0.80	1.40	0.031	0.055
E	3.35	4.05	0.132	0.159
F	0.35	1.10	0.0137	0.043
G	-	0.1	-	0.004
H	0.05	0.25	0.002	0.010

Ordering Information

Device	Package	Shipping
SMF5.0CA-SMF170CA	SOD-123FL	3000pcs / reel
SMF5.0CATR-SMF170CATR	SOD-123FL	3000pcs / reel

For information on tape and reel specifications, including part orientation and tape sizes, please refer to our tape and reel packaging specification.

Marking Diagram

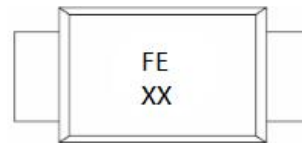

Where XX is YM

FE = Marking code
Y = Year code
M = Month code

Old marking is without date code.
New marking with date code is performed from Nov, 2020.

Carrier Tape Specification SOD-123FL

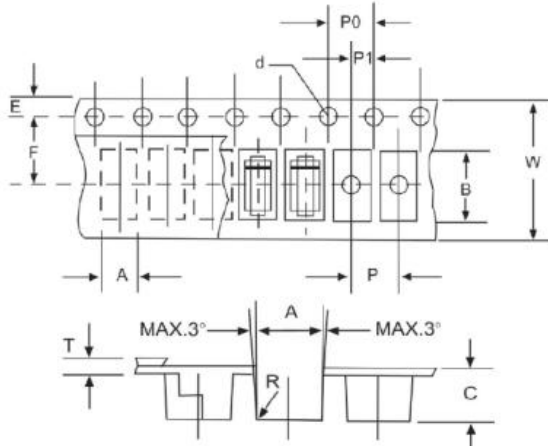

SYMBOL	Millimeters	
	Min.	Max.
A	1.95	2.15
B	3.85	4.05
C	1.35	1.55
d	1.50	1.60
E	1.65	1.85
F	3.40	3.60
P	3.90	4.10
P0	3.90	4.10
P1	1.90	2.10
W	7.90	8.30



DISCLAIMER:

- 1- The information given herein, including the specifications and dimensions, is subject to change without prior notice to improve product characteristics. Before ordering, purchasers are advised to contact the SMC Diode Solutions sales department for the latest version of the datasheet(s).
- 2- In cases where extremely high reliability is required (such as use in nuclear power control, aerospace and aviation, traffic equipment, medical equipment, and safety equipment), safety should be ensured by using semiconductor devices that feature assured safety or by means of users' fail-safe precautions or other arrangement.
- 3- In no event shall SMC Diode Solutions be liable for any damages that may result from an accident or any other cause during operation of the user's units according to the datasheet(s). SMC Diode Solution assumes no responsibility for any intellectual property claims or any other problems that may result from applications of information, products or circuits described in the datasheets.
- 4- In no event shall SMC Diode Solutions be liable for any failure in a semiconductor device or any secondary damage resulting from use at a value exceeding the absolute maximum rating.
- 5- No license is granted by the datasheet(s) under any patents or other rights of any third party or SMC Diode Solutions.
- 6- The datasheet(s) may not be reproduced or duplicated, in any form, in whole or part, without the expressed written permission of SMC Diode Solutions.
- 7- The products (technologies) described in the datasheet(s) are not to be provided to any party whose purpose in their application will hinder maintenance of international peace and safety nor are they to be applied to that purpose by their direct purchasers or any third party. When exporting these products (technologies), the necessary procedures are to be taken in accordance with related laws and regulations..