

ST560/STB560/STF560/STD560 SCHOTTKY RECTIFIER

Applications:

- Switching power supply
- Converters
- Free-Wheeling diodes
- Reverse battery protection

Features:

- 150 °C T_J operation
- Center tap configuration
- Ultralow forward voltage drop
- High purity, high temperature epoxy encapsulation for enhanced mechanical strength and moisture resistance
- High frequency operation
- Guard ring for enhanced ruggedness and long term reliability
- This is a Pb – Free Device
- All SMC parts are traceable to the wafer lot
- Additional testing can be offered upon request

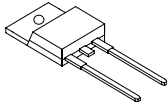
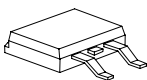
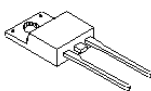
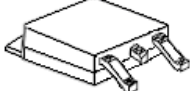
Case styles			
 ST560 TO-220AC	 STB560 D²PAK	 STF560 ITO-220AC	 STD560 DPAK

Mechanical Dimensions: In Inches / mm

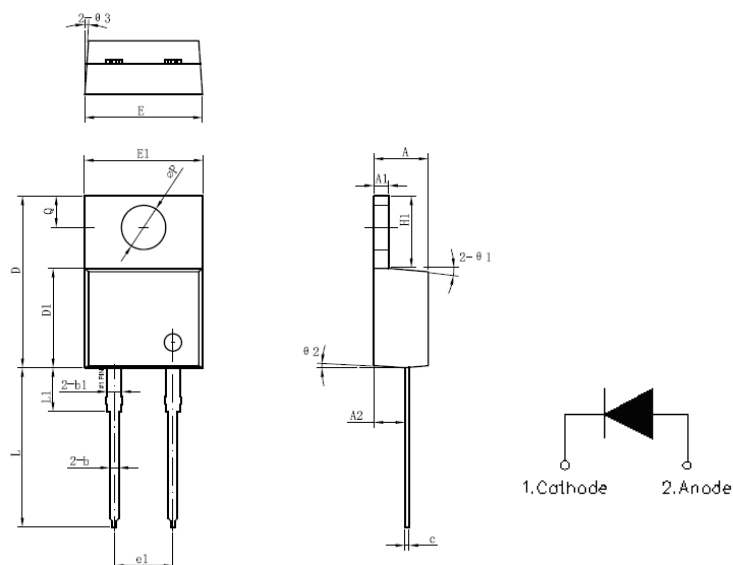

TO-220AC

Symbol	Dimensions in millimeters		
	Min.	Typical	Max.
A	4.55	4.70	4.85
A1	1.17	1.27	1.37
A2	2.59	2.69	2.89
b	0.71	0.81	0.96
b1		1.27	
c	0.36	0.38	0.61
D	14.64	14.94	15.24
D1	8.55	8.07	8.85
E	10.01	10.16	10.31
E1	9.98	10.18	10.38
e1		5.08	
H1	6.04	6.24	6.44
L	13.00	13.86	14.08
L1		3.80	
ΦP	3.74	3.84	4.04
Q	2.54	2.74	2.94
Θ1		5°	
Θ2		4°	
Θ3		4°	

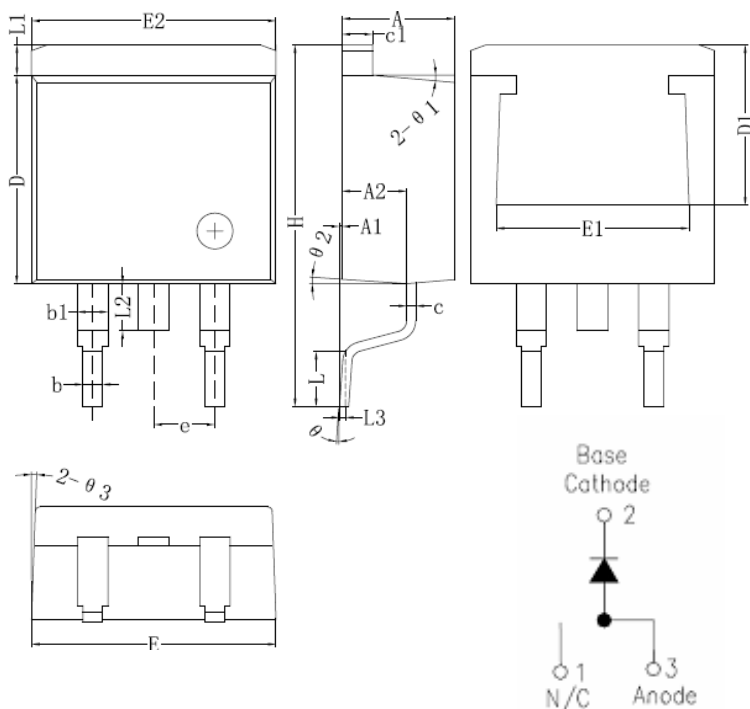

Symbol	Dimensions in millimeters		
	Min.	Typical	Max.
A	4.55	4.70	4.85
A1	0	0.10	0.25
A2	2.59	2.69	2.89
b	0.71	0.81	0.96
b1		1.27	
c	0.36	0.38	0.61
c1	1.17	1.27	1.37
D	8.55	8.70	8.85
D1	6.40		
E	10.01	10.16	10.31
E1	7.6		
E2	9.98	10.08	10.18
e		2.54	
H	14.6	15.1	15.6
L	2.00	2.30	2.70
L1	1.17	1.27	1.40
L2			2.20
L3		0.25BSC	
e	0	-	8°
e1		5°	
e2		4°	
e3		4°	

D²PAK

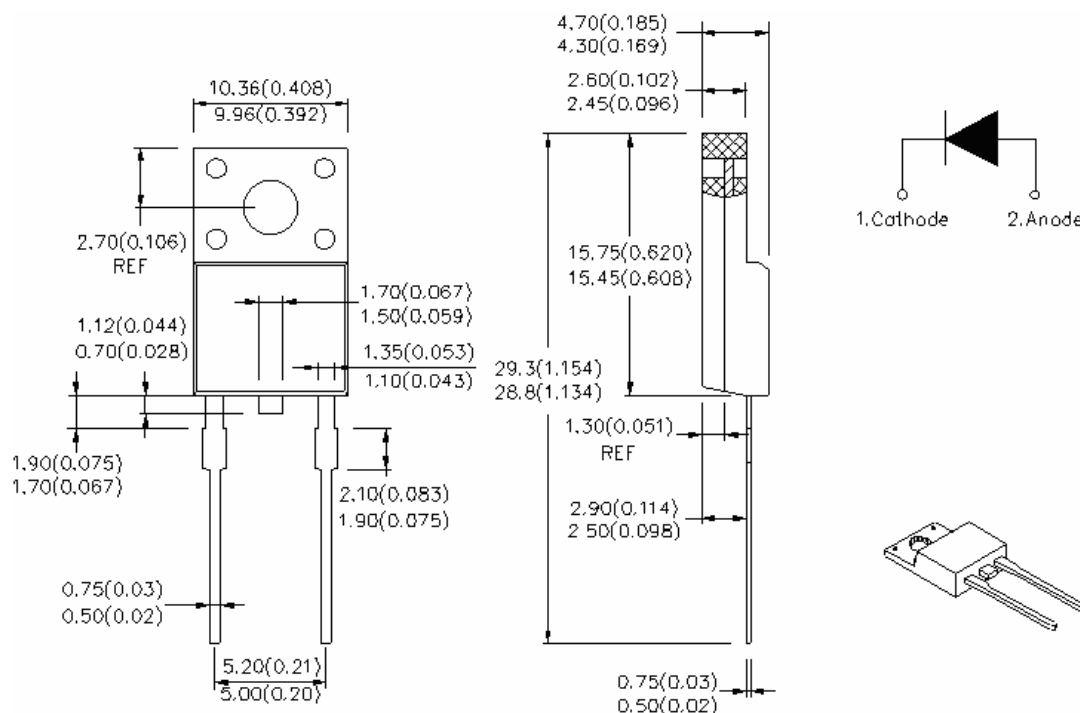

ITO-220AC

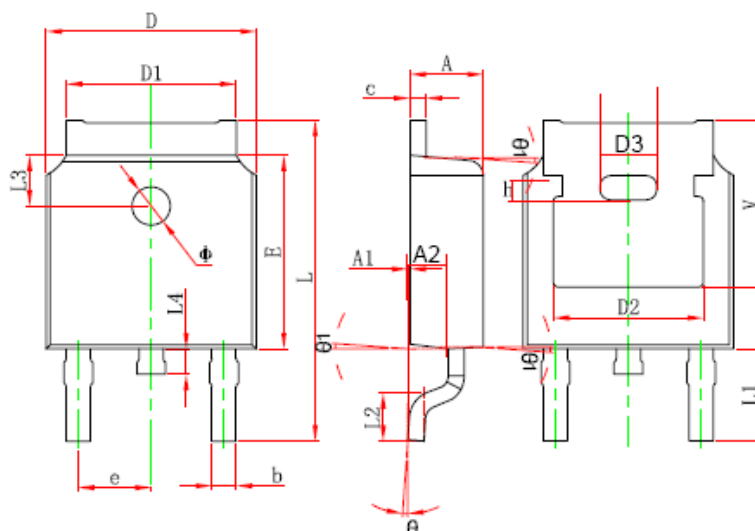

Symbol	Dimensions In Millimeters		Dimensions In Inches	
	Min.	Max.	Min.	Max.
A	2.200	2.380	0.087	0.094
A1	0.000	0.100	0.000	0.004
b	0.710	0.810	0.028	0.032
c	0.460	0.560	0.018	0.022
D	6.500	6.700	0.256	0.264
D1	5.130	5.460	0.202	0.215
D2	4.830 REF.		0.190 REF.	
E	6.000	6.200	0.236	0.244
e	2.186	2.386	0.086	0.094
L	9.800	10.400	0.386	0.409
L1	2.900 REF.		0.114 REF.	
L2	1.400	1.700	0.055	0.067
L3	1.600 REF.		0.063 REF.	
L4	0.600	1.000	0.024	0.039
Φ	1.100	1.300	0.043	0.051
θ	0°	8°	0°	8°
A2	0.910	1.110	0.036	0.044
V	5.350 REF.		0.211 REF.	
D3	1.778 REF.		0.070 REF.	
h	0.762 REF.		0.030 REF.	
θ1	7°		7°	

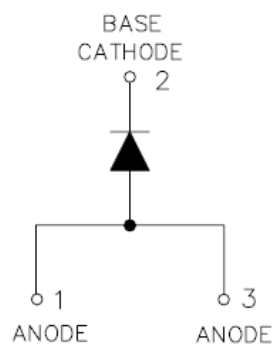

DPAK

Marking Diagram:

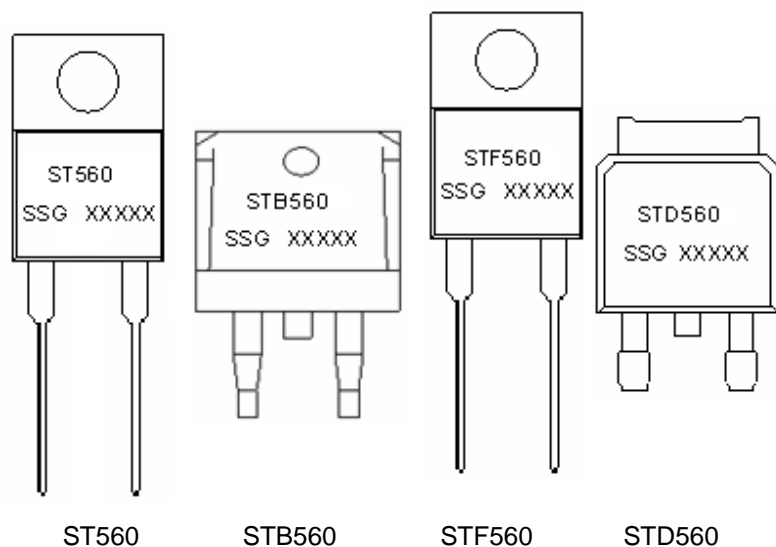

Where XXXXX is YYWWL

ST	= Device Type
B/F/D	= Package type
5	= Forward Current (5A)
60	= Reverse Voltage (60V)
SSG	= SSG
YY	= Year
WW	= Week
L	= Lot Number

Cautions: Molding resin
 Epoxy resin UL: 94V-0

Ordering Information:

Device	Package	Shipping
ST560	TO-220AC(Pb-Free)	50pcs / tube
STB560	D ² PAK(Pb-Free)	800pcs / reel
STF560	ITO-220AC(Pb-Free)	50pcs / tube
STD560	DPAK(Pb-Free)	2500pcs / reel

For information on tape and reel specifications, including part orientation and tape sizes, please refer to our Tape and Reel Packaging Specification.

Maximum Ratings:

Characteristics	Symbol	Condition	Max.	Units
Peak Inverse Voltage	V_{RWM}	-	60	V
Average Forward Current	$I_{F(AV)}$	50% duty cycle @ $T_C=100^{\circ}C$, rectangular wave form	5	A
Peak One Cycle Non-Repetitive Surge Current (per leg)	I_{FSM}	8.3 ms, half Sine pulse	100	A

Electrical Characteristics:

Characteristics	Symbol	Condition	Max.	Units
Forward Voltage Drop*	V _{F1}	@ 5A, Pulse, T _J = 25 °C	0.70	V
	V _{F2}	@ 5A, Pulse, T _J = 125 °C	0.60	V
Reverse Current*	I _{R1}	@V _R = rated V _R T _J = 25 °C	0.7	mA
	I _{R2}	@V _R = rated V _R T _J = 125 °C	25	mA

* Pulse Width < 300μs, Duty Cycle <2%

Thermal-Mechanical Specifications:

Characteristics	Symbol	ST560	STB560	STD560	STF560	Units
Junction Temperature	T _J	-55 to +150				°C
Storage Temperature	T _{stg}	-55 to +150				°C
Maximum Thermal Resistance Junction to Case(per leg)*	R _{θJC}	3.5	3.5	3.0	6.5	°C/W
Approximate Weight	wt	1.8	1.85	0.39	1.8	g
Case Style	TO-220AC/ D ² PAK/ DPAK/ ITO-220AC					



DISCLAIMER:

1- The information given herein, including the specifications and dimensions, is subject to change without prior notice to improve product characteristics. Before ordering, purchasers are advised to contact the SMC - Sangdest Microelectronics (Nanjing) Co., Ltd sales department for the latest version of the datasheet(s).

2- In cases where extremely high reliability is required (such as use in nuclear power control, aerospace and aviation, traffic equipment, medical equipment, and safety equipment), safety should be ensured by using semiconductor devices that feature assured safety or by means of users' fail-safe precautions or other arrangement.

3- In no event shall SMC - Sangdest Microelectronics (Nanjing) Co., Ltd be liable for any damages that may result from an accident or any other cause during operation of the user's units according to the datasheet(s). SMC - Sangdest Microelectronics (Nanjing) Co., Ltd assumes no responsibility for any intellectual property claims or any other problems that may result from applications of information, products or circuits described in the datasheets.

4- In no event shall SMC - Sangdest Microelectronics (Nanjing) Co., Ltd be liable for any failure in a semiconductor device or any secondary damage resulting from use at a value exceeding the absolute maximum rating.

5- No license is granted by the datasheet(s) under any patents or other rights of any third party or SMC - Sangdest Microelectronics (Nanjing) Co., Ltd.

6- The datasheet(s) may not be reproduced or duplicated, in any form, in whole or part, without the expressed written permission of SMC - Sangdest Microelectronics (Nanjing) Co., Ltd.

7- The products (technologies) described in the datasheet(s) are not to be provided to any party whose purpose in their application will hinder maintenance of international peace and safety nor are they to be applied to that purpose by their direct purchasers or any third party. When exporting these products (technologies), the necessary procedures are to be taken in accordance with related laws and regulations..