

**FTB1F-15F THRU FTB10F-15F
1.5A SURFACE MOUNT GLASS PASSIVATED BRIDGE RECTIFIER**

Features:

- Glass Passivated Chip Junction
- Reverse Voltage - 100 to 1000 V
- Forward Current - 1.5 A
- Designed for Surface Mount Application
- Fast reverse recovery time
- This is a Halogen Free Device
- All SMC parts are traceable to the wafer lot
- Additional testing can be offered upon request

PIN	DESCRIPTION
1	Input Pin (~)
2	Input Pin (~)
3	Output Anode (+)
4	Output Cathode (-)

Mechanical Data:

- Case: ABF
- Terminals: Solderable per MIL-STD-750, Method 2026
- Weight: 82 mg

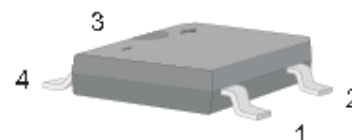

Mechanical Dimensions: In mm/mil

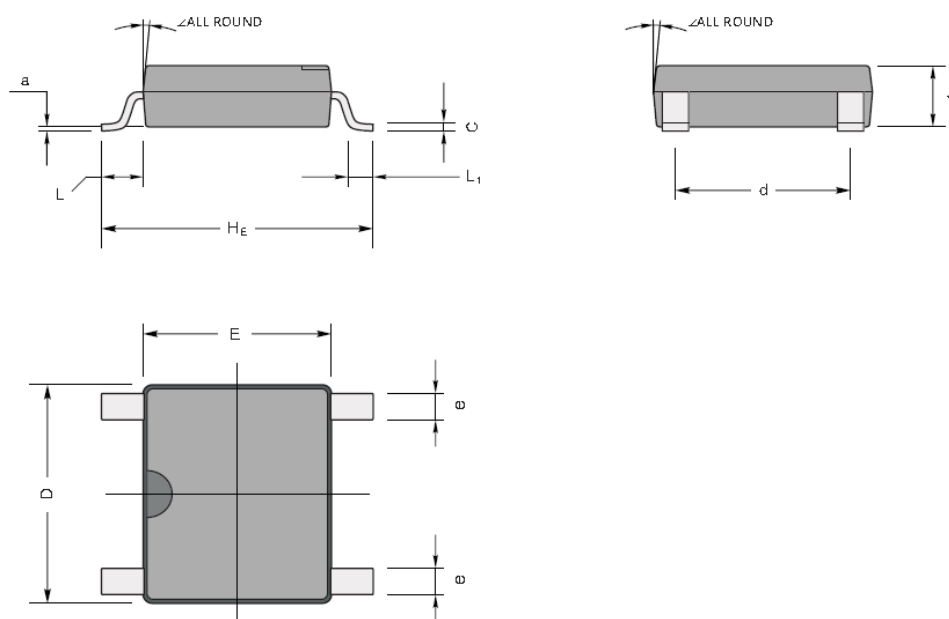

UNIT		A	C	D	E	HE	d	e	L	L1	a	∠
mm	max	1.2	0.22	5.2	4.5	6.4	4.2	0.7	0.95	0.6	0.2	7°
	min	1.0	0.15	4.9	4.2	6.0	3.8	0.5				
mil	max	47	8.7	205	177	252	165	28	37	24	4	
	min	39	5.9	193	166	236	150	20				

ABF

- China - Germany - Korea - Singapore - United States •
- <http://www.smc-diodes.com> - sales@smc-diodes.com •

The recommended mounting pad size:

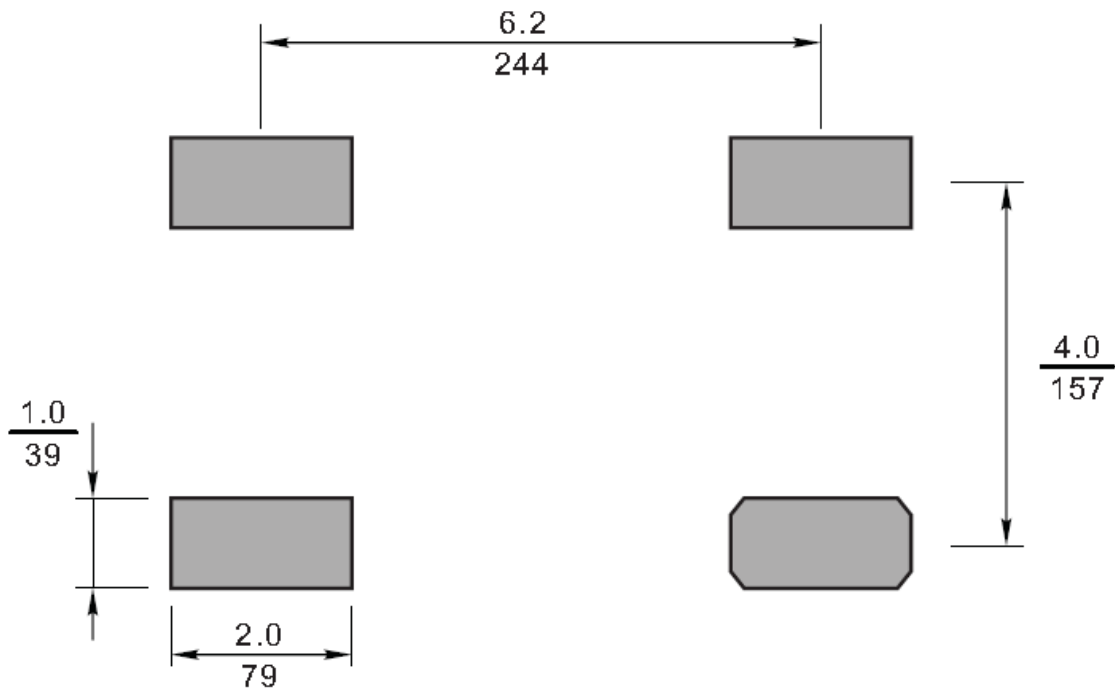

Unit : $\frac{\text{mm}}{(\text{mil})}$

Marking Diagram:

Type number	Marking code
FTB1F-15F	F15F1F
FTB2F-15F	F15 F2F
FTB4F-15F	F15F4F
FTB6F-15F	F15F6F
FTB8F-15F	F15F8F
FTB10F-15F	F15F10F

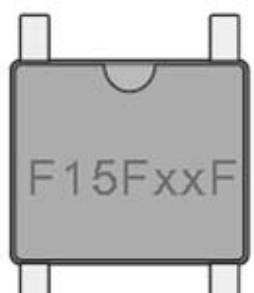



**FTB1F-15F
THRU
FTB10F-15F**

Technical Data
Data Sheet N1743, Rev. -

Green Products

Maximum Ratings and Electrical Characteristics @ $T_A=25^\circ\text{C}$ unless otherwise specified

Single Phase, half wave, 60Hz, resistive or inductive load.

For capacitive load, derate current by 20%.

Characteristic	Symbol	FTB1F -15F	FTB2F -15F	FTB4F -15F	FTB6F -15F	FTB8F -15F	FTB10F -15F	Units
Maximum repetitive peak reverse voltage	V_{RRM}	100	200	400	600	800	1000	V
Maximum RMS voltage	V_{RMS}	70	140	280	420	560	700	V
Maximum DC blocking voltage	V_{DC}	100	200	400	600	800	1000	V
Average Rectified Output Current at $T_A=50^\circ\text{C}$	I_o	1.5						A
Peak forward surge current 8.3ms single half sine-wave superimposed on rated load (JEDEC Method)	I_{FSM}	50						A
Maximum instantaneous forward voltage at 1.5A	V_F	1.3						V
Maximum DC reverse current $T_A=25^\circ\text{C}$ at rated DC blocking voltage $T_A=125^\circ\text{C}$	I_R	5.0 100						μA
Typical Junction Capacitance (Note 1)	C_J	25						pF
Typical Thermal Resistance (Note 2)	$R_{\theta JA}$	80						$^\circ\text{C}/\text{W}$
Maximum Reverse Recovery Time (Note 3)	T_{rr} $T_{rr(TYP.)}$	500 300						ns
Junction Temperature	T_J	-55 to +150						$^\circ\text{C}$
Storage Temperature Range	T_{STG}	-55 to +150						$^\circ\text{C}$

Note: 1. Measured at 1.0 MHz and applied reverse voltage of 4.0V D.C.

2. Mounted on glass epoxy PC board with $4 \times (5 \times 5\text{mm}^2)$ copper pad.

3. Reverse Recovery Test Conditions: $I_F=0.5\text{A}$, $I_R=1.0\text{A}$, $IRR=0.25\text{A}$

Fig.1 Average Rectified Output Current Derating Curve

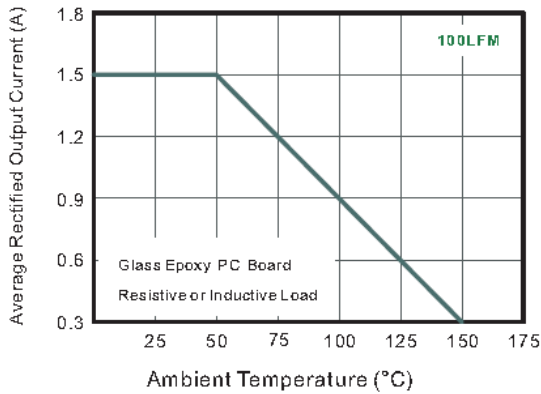

Fig.2 Typical Reverse Characteristics

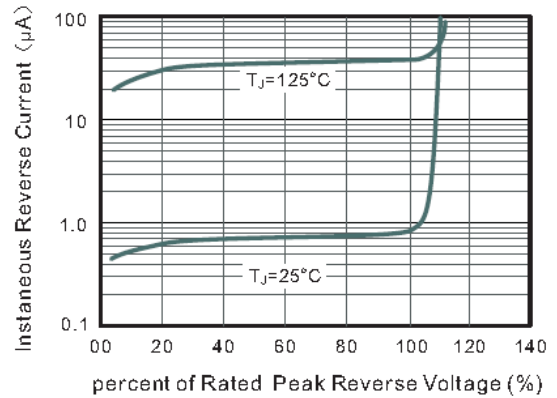

Fig.3 Typical Instantaneous Forward Characteristics

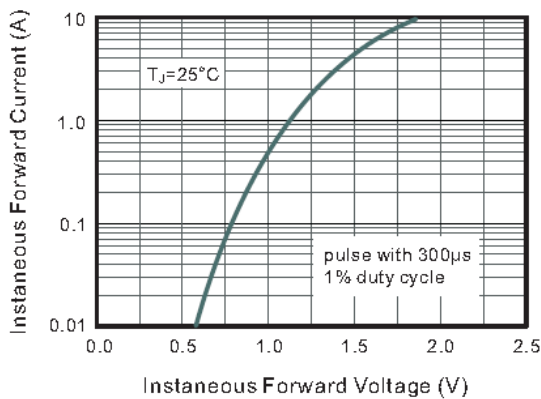

Fig.4 Typical Junction Capacitance

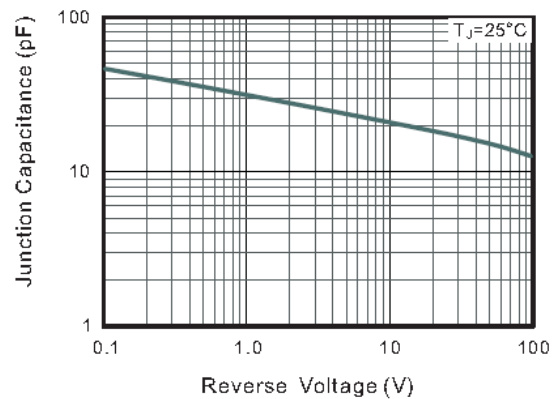
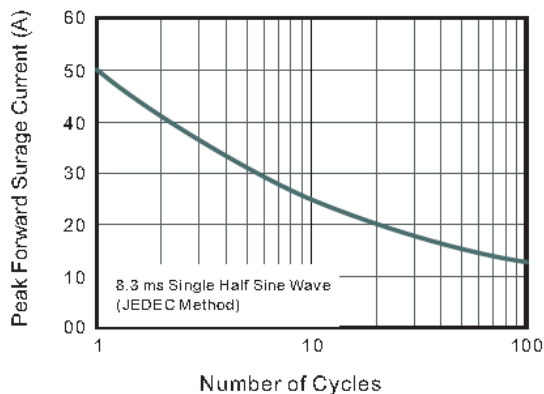

Fig.5 Maximum Non-Repetitive Peak Forward Surge Current





DISCLAIMER:

1- The information given herein, including the specifications and dimensions, is subject to change without prior notice to improve product characteristics. Before ordering, purchasers are advised to contact the SMC - Sangdest Microelectronics (Nanjing) Co., Ltd sales department for the latest version of the datasheet(s).

2- In cases where extremely high reliability is required (such as use in nuclear power control, aerospace and aviation, traffic equipment, medical equipment, and safety equipment), safety should be ensured by using semiconductor devices that feature assured safety or by means of users' fail-safe precautions or other arrangement.

3- In no event shall SMC - Sangdest Microelectronics (Nanjing) Co., Ltd be liable for any damages that may result from an accident or any other cause during operation of the user's units according to the datasheet(s). SMC - Sangdest Microelectronics (Nanjing) Co., Ltd assumes no responsibility for any intellectual property claims or any other problems that may result from applications of information, products or circuits described in the datasheets.

4- In no event shall SMC - Sangdest Microelectronics (Nanjing) Co., Ltd be liable for any failure in a semiconductor device or any secondary damage resulting from use at a value exceeding the absolute maximum rating.

5- No license is granted by the datasheet(s) under any patents or other rights of any third party or SMC - Sangdest Microelectronics (Nanjing) Co., Ltd.

6- The datasheet(s) may not be reproduced or duplicated, in any form, in whole or part, without the expressed written permission of SMC - Sangdest Microelectronics (Nanjing) Co., Ltd.

7- The products (technologies) described in the datasheet(s) are not to be provided to any party whose purpose in their application will hinder maintenance of international peace and safety nor are they to be applied to that purpose by their direct purchasers or any third party. When exporting these products (technologies), the necessary procedures are to be taken in accordance with related laws and regulations..